

# ZXMN10A09K

---

## 100V N-CHANNEL ENHANCEMENT MODE MOSFET IN DPAK

---

### SUMMARY

$V_{(BR)DSS}=100V$  ;  $R_{DS(on)}=0.085\Omega$ ;  $I_D=7.7A$

### DESCRIPTION

This new generation of Trench MOSFETs from Zetex utilizes a unique structure that combines the benefits of low on-resistance with fast switching speed. This makes them ideal for high efficiency, low voltage power management applications.

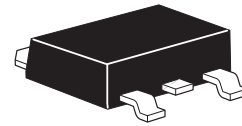

DPAK

### FEATURES

- Low on-resistance
- Fast switching speed
- Low gate drive
- D-Pak (T0-252) package

### APPLICATIONS

- DC-DC Converters
- Power management functions
- Disconnect switches
- Motor control

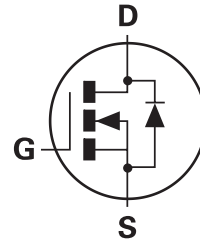

### ORDERING INFORMATION

DEVICE	REEL SIZE	TAPE WIDTH	QUANTITY PER REEL
ZXMN10A09KTC	13"	16mm	2,500 units

### DEVICE MARKING

- ZXMN  
10A09K

### PINOUT

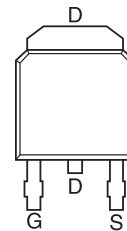

TOP VIEW

# ZXMN10A09K

## ABSOLUTE MAXIMUM RATINGS

PARAMETER	SYMBOL	LIMIT	UNIT
Drain-source voltage	$V_{DSS}$	100	V
Gate-source voltage	$V_{GS}$	$\pm 20$	V
Continuous drain current @ $V_{GS}=10V$ ; $T_A=25^\circ C$ <sup>(b)</sup> @ $V_{GS}=10V$ ; $T_A=70^\circ C$ <sup>(b)</sup> @ $V_{GS}=10V$ ; $T_A=25^\circ C$ <sup>(a)</sup>	$I_D$	7.7 6.2 5	A A A
Pulsed drain current <sup>(c)</sup>	$I_{DM}$	27	A
Continuous source current (body diode) <sup>(b)</sup>	$I_S$	11	A
Pulsed source current (body diode) <sup>(c)</sup>	$I_{SM}$	27	A
Power dissipation at $T_A = 25^\circ C$ <sup>(a)</sup> Linear derating factor	$P_D$	4.3 34.4	W mW/ $^\circ C$
Power dissipation at $T_A = 25^\circ C$ <sup>(b)</sup> Linear derating factor	$P_D$	10.1 80.8	W mW/ $^\circ C$
Power dissipation at $T_A = 25^\circ C$ <sup>(d)</sup> Linear derating factor	$P_D$	2.15 17.2	W mW/ $^\circ C$
Operating and storage temperature range	$T_j, T_{stg}$	-55 to +150	$^\circ C$

## THERMAL RESISTANCE

PARAMETER	SYMBOL	VALUE	UNIT
Junction to ambient <sup>(a)</sup>	$R_{\theta JA}$	29	$^\circ C/W$
Junction to ambient <sup>(b)</sup>	$R_{\theta JA}$	12.3	$^\circ C/W$
Junction to ambient <sup>(d)</sup>	$R_{\theta JA}$	58	$^\circ C/W$

### NOTES

(a) For a device surface mounted on 50mm x 50mm x 1.6mm FR4 PCB with high coverage of single sided 2oz copper, in still air conditions.

(b) For a device surface mounted on FR4 PCB measured at  $t \leq 10$  sec.

(c) Repetitive rating 50mm x 50mm x 1.6mm FR4 PCB,  $D=0.02$  pulse width=300 $\mu s$  - pulse width limited by maximum junction temperature.

(d) For a device surface mounted on 25mm x 25mm x 1.6mm FR4 PCB with high coverage of single sided 1oz copper, in still air conditions.

# ZXMN10A09K

## TYPICAL CHARACTERISTICS

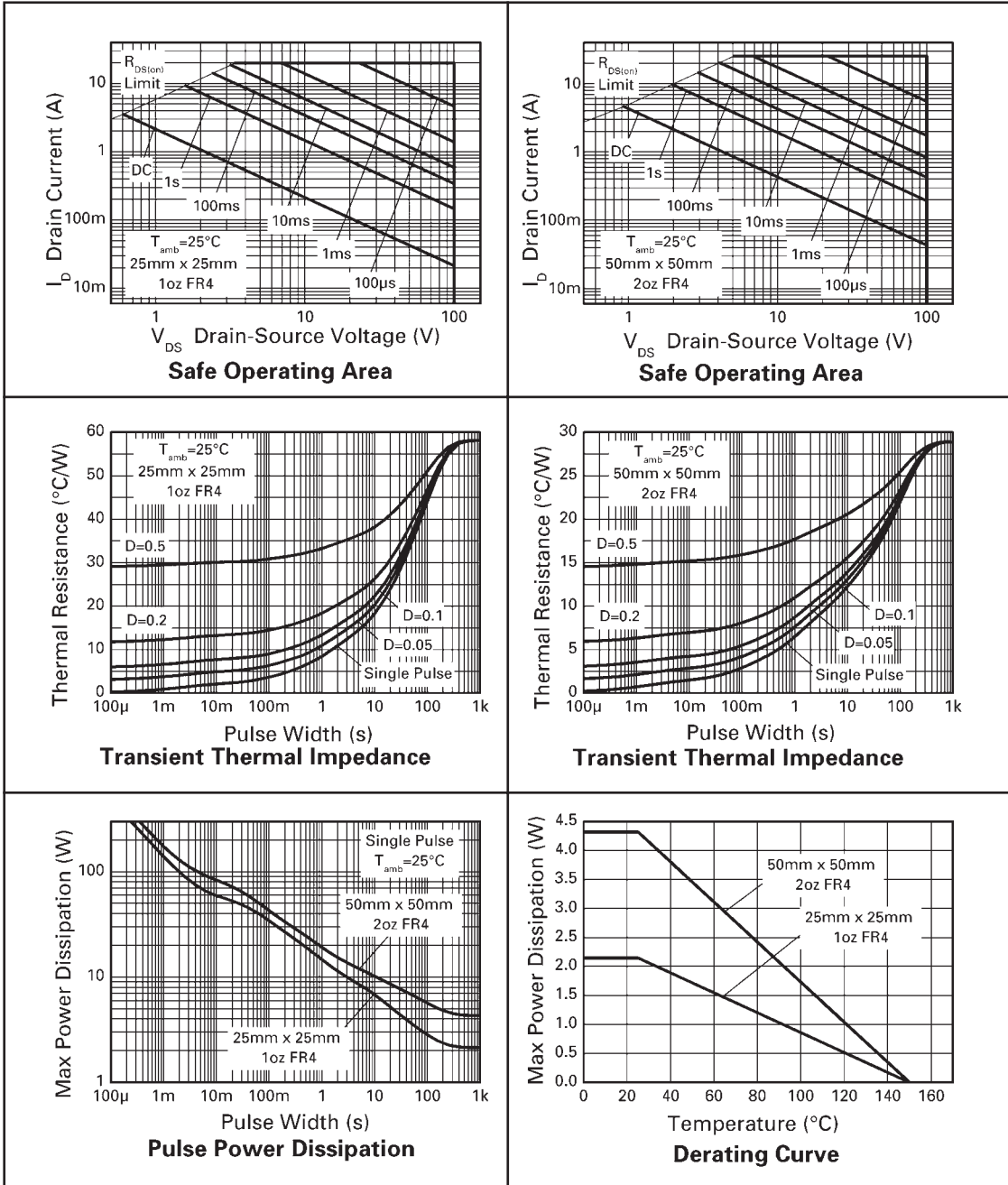

# ZXMN10A09K

## ELECTRICAL CHARACTERISTICS (at $T_{amb} = 25^{\circ}\text{C}$ unless otherwise stated)

PARAMETER	SYMBOL	MIN.	TYP.	MAX.	UNIT	CONDITIONS
<b>STATIC</b>						
Drain-source breakdown voltage	$V_{(BR)DSS}$	100			V	$I_D = 250\mu\text{A}$ , $V_{GS} = 0\text{V}$
Zero gate voltage drain current	$I_{DSS}$			1	$\mu\text{A}$	$V_{DS} = 100\text{V}$ , $V_{GS} = 0\text{V}$
Gate-body leakage	$I_{GSS}$			100	nA	$V_{GS} = \pm 20\text{V}$ , $V_{DS} = 0\text{V}$
Gate-source threshold voltage	$V_{GS(th)}$	2.0		4.0	V	$I_D = 250\mu\text{A}$ , $V_{DS} = V_{GS}$
Static drain-source on-state resistance <sup>(1)</sup>	$R_{DS(on)}$			0.085	$\Omega$	$V_{GS} = 10\text{V}$ , $I_D = 4.6\text{A}$
				0.100	$\Omega$	$V_{GS} = 6\text{V}$ , $I_D = 4.2\text{A}$
Forward transconductance <sup>(1) (3)</sup>	$g_{fs}$		10.7		S	$V_{DS} = 15\text{V}$ , $I_D = 4.6\text{A}$
<b>DYNAMIC <sup>(3)</sup></b>						
Input capacitance	$C_{iss}$		1313		pF	$V_{DS} = 50\text{V}$ , $V_{GS} = 0\text{V}$ $f = 1\text{MHz}$
Output capacitance	$C_{oss}$		83		pF	
Reverse transfer capacitance	$C_{rss}$		56		pF	
<b>SWITCHING <sup>(2) (3)</sup></b>						
Turn-on-delay time	$t_{d(on)}$		6.8		ns	$V_{DD} = 50\text{V}$ , $I_D = 1\text{A}$ $R_G \approx 6.0\Omega$ , $V_{GS} = 10\text{V}$
Rise time	$t_r$		5.3		ns	
Turn-off delay time	$t_{d(off)}$		27.5		ns	
Fall time	$t_f$		12.3		ns	
Total gate charge	$Q_g$		17.2		nC	$V_{DS} = 50\text{V}$ , $V_{GS} = 6\text{V}$ $I_D = 4.6\text{A}$
Total gate charge	$Q_g$		26		nC	$V_{DS} = 50\text{V}$ , $V_{GS} = 10\text{V}$ $I_D = 4.6\text{A}$
Gate-source charge	$Q_{gs}$		5.6		nC	
Gate drain charge	$Q_{gd}$		7.6		nC	
<b>SOURCE-DRAIN DIODE</b>						
Diode forward voltage <sup>(1)</sup>	$V_{SD}$		0.85	0.95	V	$T_j = 25^{\circ}\text{C}$ , $I_F = 4.7\text{A}$ , $V_{GS} = 0\text{V}$
Reverse recovery time <sup>(3)</sup>	$t_{rr}$		40		ns	$T_j = 25^{\circ}\text{C}$ , $I_S = 3\text{A}$ ,
Reverse recovery charge <sup>(3)</sup>	$Q_{rr}$		62		nC	$di/dt = 100\text{A}/\mu\text{s}$

### NOTES

(1) Measured under pulsed conditions. Pulse width  $\leq 300\mu\text{s}$ ; duty cycle  $\leq 2\%$ .

(2) Switching characteristics are independent of operating junction temperature.

(3) For design aid only, not subject to production testing.

# ZXMN10A09K

## TYPICAL CHARACTERISTICS

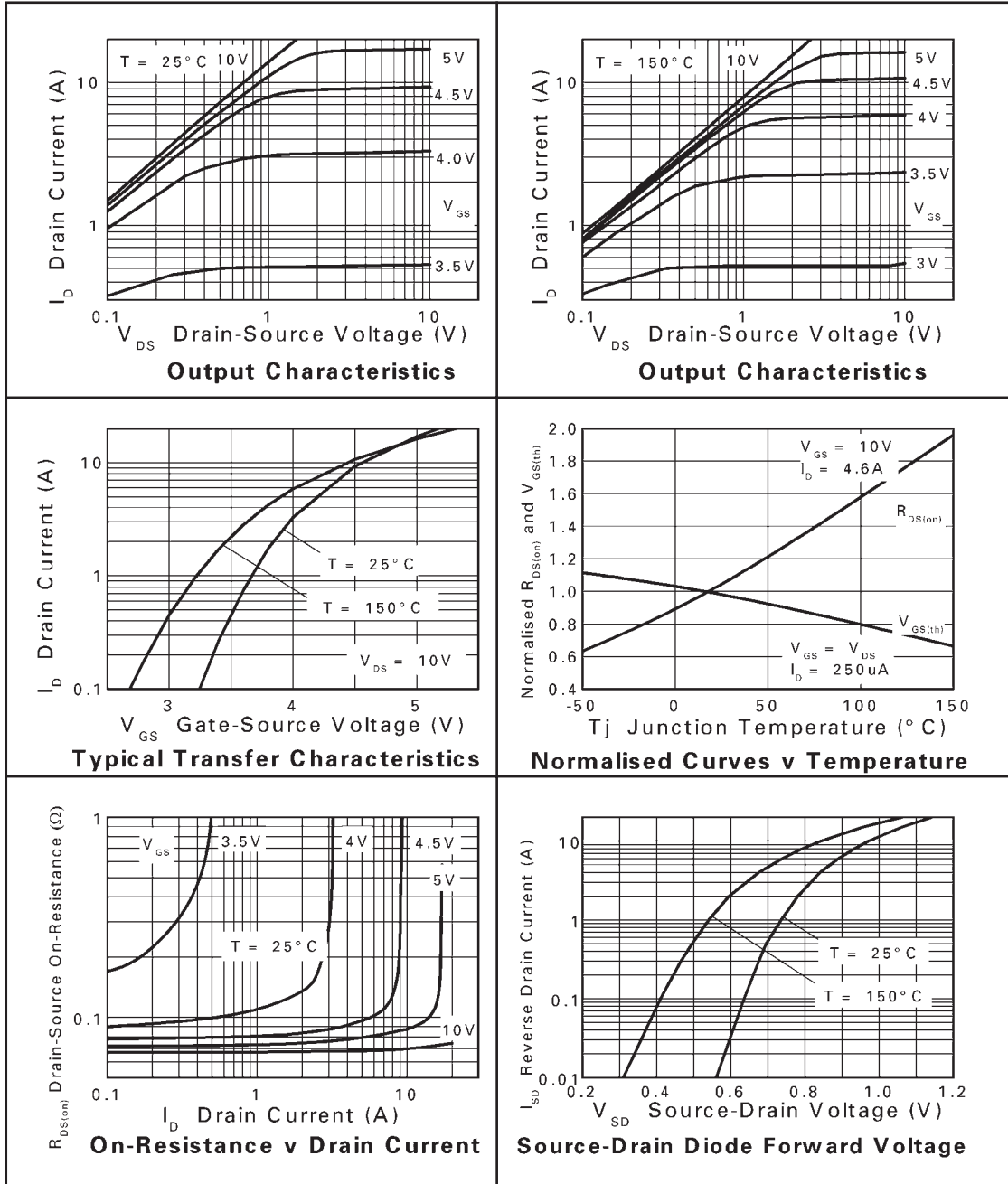

# ZXMN10A09K

## TYPICAL CHARACTERISTICS

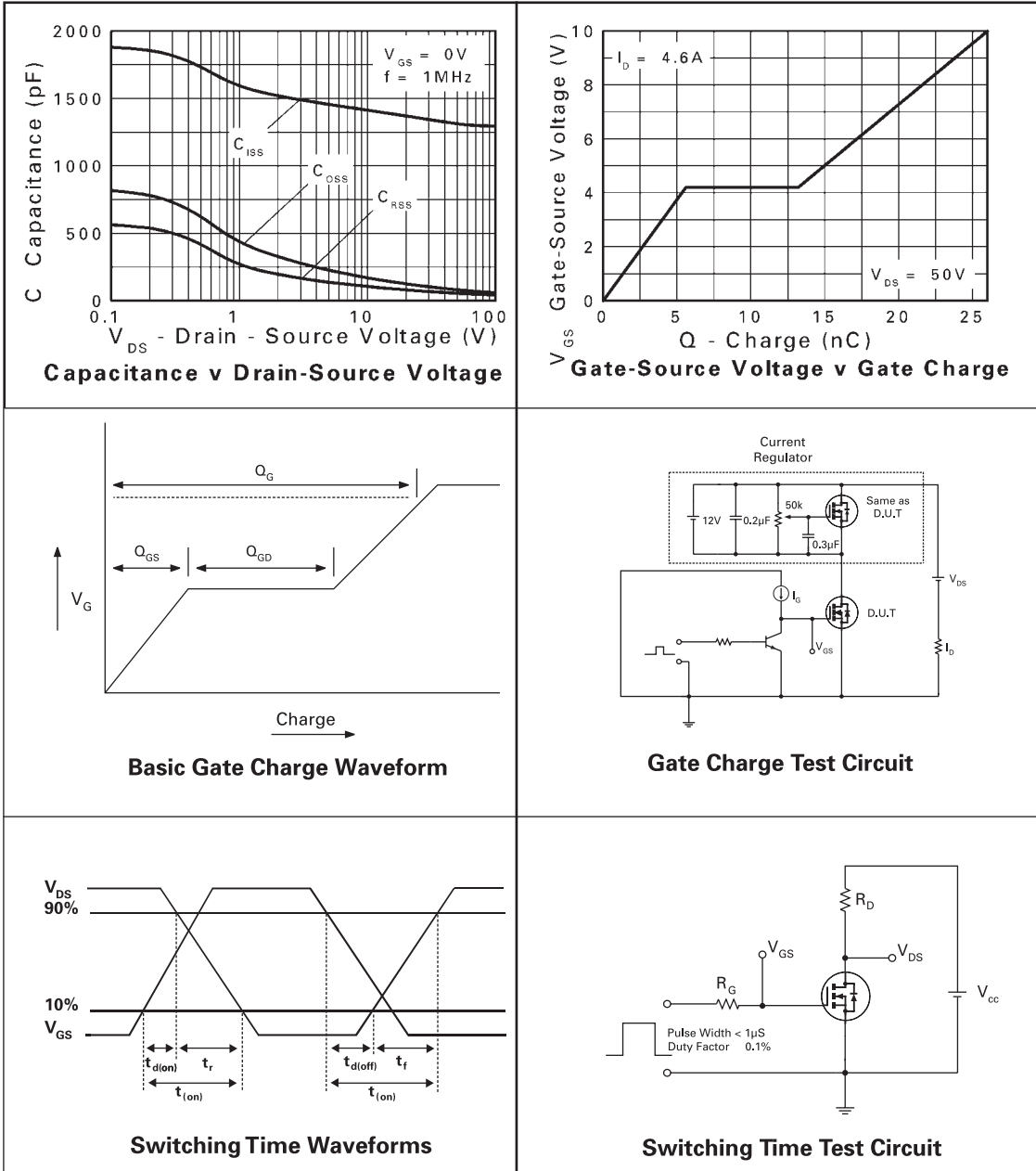

# ZXMN10A09K

## PACKAGE OUTLINE

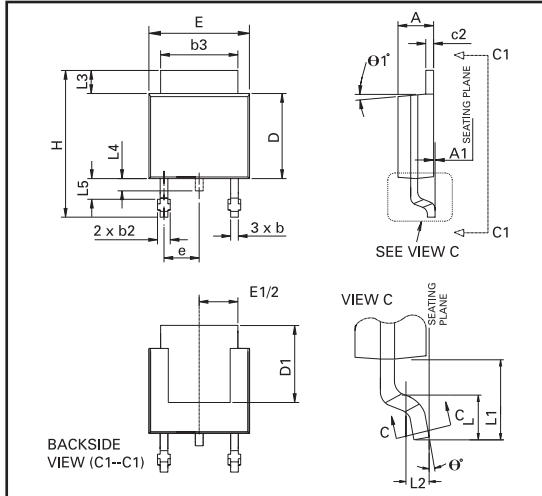

Controlling dimensions are in millimeters. Approximate conversions are given in inches

## PACKAGE DIMENSIONS

DIM	Millimeters		Inches		DIM	Millimeters		Inches	
	Min	Max	Min	Max		Min	Max	Min	Max
A	2.18	2.38	0.086	0.094	e	2.30 BSC		0.090 BSC	
A1	—	0.127	—	0.005	H	9.40	10.41	0.370	0.410
b	0.635	0.89	0.025	0.035	L	1.40	1.78	0.055	0.070
b2	0.762	1.114	0.030	0.045	L1	2.74 REF		0.108 REF	
b3	5.20	5.46	0.205	0.215	L2	0.051 BSC		0.020 BSC	
c	0.457	0.609	0.018	0.024	L3	0.89	1.27	0.035	0.050
c2	0.457	0.584	0.018	0.023	L4	0.635	1.01	0.025	0.040
D	5.97	6.22	0.235	0.245	L5	1.14	1.52	0.045	0.060
D1	5.20	—	0.205	—	theta 1°	0°	10°	0°	10°
E	6.35	6.73	0.250	0.265	theta°	0°	15°	0°	15°
E1	4.32	—	0.170	—	—	—	—	—	—

© Zetex Semiconductors plc 2005

Europe	Americas	Asia Pacific	Corporate Headquarters
Zetex GmbH Streitfeldstraße 19 D-81673 München Germany	Zetex Inc 700 Veterans Memorial Hwy Hauppauge, NY 11788 USA	Zetex (Asia) Ltd 3701-04 Metroplaza Tower 1 Hing Fong Road, Kwai Fong Hong Kong	Zetex Semiconductors plc Zetex Technology Park Chadderton, Oldham, OL9 9LL United Kingdom
Telephone: (49) 89 45 49 49 0 Fax: (49) 89 45 49 49 49 <a href="mailto:europe.sales@zetex.com">europe.sales@zetex.com</a>	Telephone: (1) 631 360 2222 Fax: (1) 631 360 8222 <a href="mailto:usa.sales@zetex.com">usa.sales@zetex.com</a>	Telephone: (852) 26100 611 Fax: (852) 24250 494 <a href="mailto:asia.sales@zetex.com">asia.sales@zetex.com</a>	Telephone (44) 161 622 4444 Fax: (44) 161 622 4446 <a href="mailto:hq@zetex.com">hq@zetex.com</a>

These offices are supported by agents and distributors in major countries world-wide.

This publication is issued to provide outline information only which (unless agreed by the Company in writing) may not be used, applied or reproduced for any purpose or form part of any order or contract or be regarded as a representation relating to the products or services concerned. The Company reserves the right to alter without notice the specification, design, price or conditions of supply of any product or service.

For the latest product information, log on to [www.zetex.com](http://www.zetex.com)

ISSUE 6 - JANUARY 2005